

electronic
Valve
Protector

electronic-dosage-system

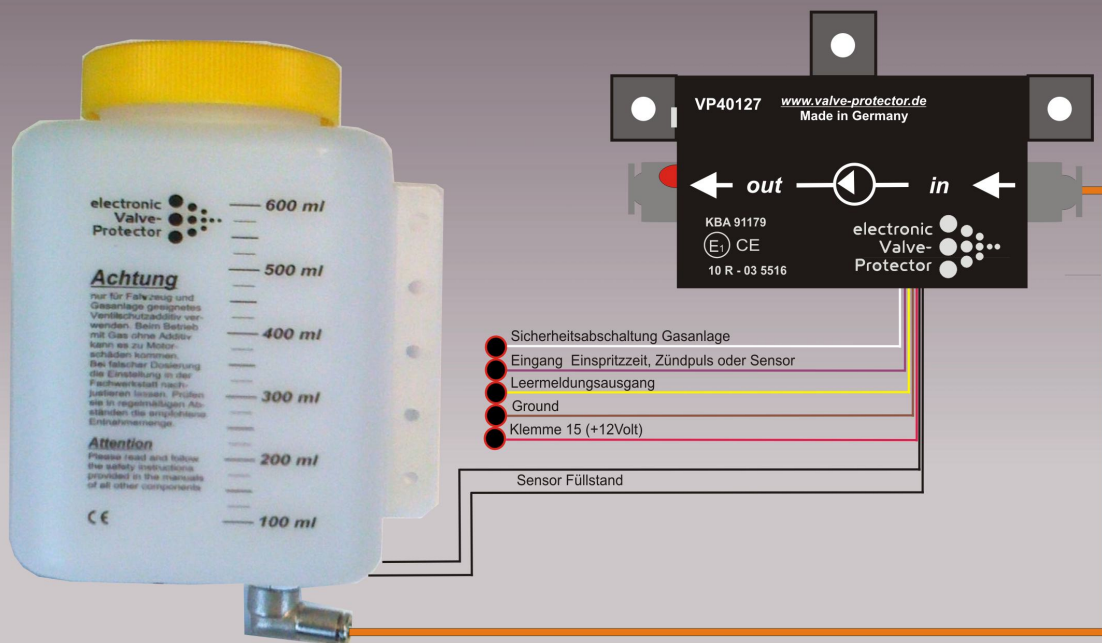

Technical Manual

Installation Instructions
Safety Notices
Programming
Operation

SI-Elektronik GmbH * Max-Planck-Straße 5 * 63477 Maintal * www.valve-protector.de * 06181/9436-00

congratulation

we congratulate you to the bargain of the Additive-dosage-system
„electronic-Valve-Protector“
with highest quality and we thank you for your confidence

By using this dosage system in connection with an usable value protector you can really reduce the sign of wear of the engine tools before using the system please read the operating instruction for using, for the connection the security information and the setting.

caution

all rights reserved the contents of this book belongs to si elektronik gmbh.
A copy or the reproduction of this book or a choice of the book needs the approval of si elektronik gmbh
errors or misprints and changes excepted. we are not responsible for defects, losses or costs which arise for the buyer or a third person-and are caused by wrong using, accident for a purpose not intended respectively improver repairs or improver connections.

please only use origin replacement parts or fittings

we do also not accept liability for consequential damages and losts, which are caused by this products.

<p>SI-Elektronik GmbH Max-Planck-Straße 5 D-63477 Maintal</p>
--

Index

Index.....	3
Introduction.....	4
functional using.....	4
using by cars driving with gas.....	4
how does valve protector work.....	5
the adjustable basic functions for the additive quantity calculation... 5	5
1. gas valve timing.....	5
2. number of revolutions p.m.....	6
3.interval.....	6
The additive introducing.....	6
1. additive nozzle M5 including check valve.....	6
2. additive flank including check valve.....	7
additive tank.....	8
dosage unit.....	9
electric connection valve protector.....	10
component drawing.....	11
connection plan sensitive relays for switching of.....	12
fitting and starting electronic valve protector.....	13-15
quick start instructions – Amount setting.....	16
safety directions.....	17

introduction

functional using

valve protector is an electric regulated dosage and consist of the following components:

additive tank, electronic regulated dosage module, introducing connection-switch or nozzle

The functional using is to add the qualified and decontrolled additives for combustion engines.

Valve protector is developed and built based by the validate safety guidelines for using in european community.

The electronic additive dosage system makes a volume control or rather consume depend commit by additives or lubricating oil possible, which work against sign of wear from component parts as well as from bearing or tracks..

using by cars driving with gas

cars without gas firmed cylinder head and soft valve for the optimal lubrication and to protect the valve an additive must get in to the burner by a dosage fitting.the optimal contribution as well as the distribution of the additive is very necessary. the recommended additive dosage is instructed by the producers 1‰ additive in the preposition to the needed gas injectors.(Look at the instructions of the manufacturers)

the right dosage as well as the right providing of the relevant component parts makes the right effectiveness of a dosage system. by many dosage systems this criterions are not served and are only a cover up function for a well conscience

the right dosage

example for 1‰

If your car needs 100 litre gas for a length of 1000 km it is optimal when you need 100 ml additive.

so you need a quantity of additive of 500 ml for a length of 5000 km
The consumption of the additive in relation to the consumption of the gas is linear.

if your car needs more gas you also need more additive.the example you can see here is for a dosage of 1‰
please look the instructions of your additive manufacturers.

Valve Protector offers the following performance characteristics:

1. additive only needed if required
2. no overdose or rather low dose
3. constant or rather consume dependent additive admixture for the complete work of your engine
4. warning if the additive is empty.
5. if necessary the gas installation gets out or order then additive is empty
6. the installation is very easy because of little component parts
7. ideal additive distribution because of starting into the gas phase
8. refill the additive tank is very easy
9. easy to install later
10. all sealings of the system are of high-class FKM
11. favourable purchase costs
12. qualified for using by turbo engines also

how does valve protector work

The system is made of an additive tank and additive pump with installed electronic controller .To calculate the additive quantity you can use different parameter:

The adjustable basic functions for the calculation of additive quantity

1.gas or gasoline control times

By this art of using the exactly dosage of the additive in the relation to the used fuel quantity will be reached up to the control entry of the valve protector module (mauve wire) the control times of any gas- respectively gasoline nozzle are measured and multiply by the declared cylinder number.

2. How longer the opening time of the nozzles, you get more additive. If you drive in gasoline running and the gas nozzles are switched off, you get no additives. The microprocessor in the dosage module adds the particular control times up to the adjusted dosage level. Now an additive push is starting and the dosage calculator put back to zero.

the microprocessor adds the individual control times up to the setting dosage threshold is reached. Now the additive surge turn to reduce and the dosage calculator put back to zero by turbo engines the higher system counter movements and the so connected higher gas quantities by the same injection time will be adapt by a code line in the valve protector.

2.revolution / Impuls

From the control entrance of the valve protector module/mauve) the spark impulse will be taken off by the ignition coil. the microprocessor adds the numbers of the impulse up to the focussing dosage threshold is reached. now an additive surge is starting. and the impulse counter set up to zero. By this doing also short periods gas surges will be considered and the corresponding additive quantity will be delivered. But an overdose is possible, because a high revolution without load does not cause a high gasoline consume by engines without electronic injection this doing is the best possibility and makes a pleased additive dosage possible when you drive normal.

for attention: the valve protector system only should be provided with voltage in the LPG mode, to make it unable that additive gets in during gasoline mode.

3. Interval

By this function the additive contribution will be produced in a fixed space of time. the time up to the next additive tick can be set in the field of 1-999 sec. this operation is looked for engines with equal loading, which also have an equal gas consume. therefore you also have an equal dosage of the additive.

for attention: the valve protector system you only supply with tension when it operates by gas, to prevent an additive contribution when it operates with gasoline..

the Additive introduction

The introduction of the additive respectively lubricant either happens

1.additive nozzle m5 included check valve

By lpg engines, operating with direct injection, the additive will get in the intake manifold behind the throttle by the additive nozzle. The installation behind the throttle is possible because of using the negative-pressure compensated nozzle.

The using of the additive socket is recommended for the following applications:
LPG systems without evaporator cars with other additive lead, track lubricate



2. additive flank included check valve

By engines driving with gas evaporator

Instructions the additive can be injected with the additive switch after the evaporator into the low pressure side. you can have values of 10,12 and 16 mm tube connections. The T-fitting will be delivered including clips and easily installed in the gas way by cutting off the gas tube behind the evaporator because of the gas flow the additive takes along and comes into the burner through the injection nozzle. To prevent that the rest of the additive flows back into the evaporator it is advisable to install the additive flank with a gradient in line of the nozzle.the additive can get over an opposition pressure in the gas system up to 4,5 bar. The system therefore is also qualified for turbo engines the installed setback valve protects the valve protector system for over pressure and prevents an escape of gas when the additive pipeline is defect. you have the advantage that you can take away the additive pipeline also when the gas construction is active. by this operation additive gets into the gas flew, please look at the customer instructions because of the sociable material.



the additive tank

The additive tank is built with an level sensor and early signs you when you have to fill up the additive.

The tube connection is designed by a rotatory quick plug in connection. by the imprint in 25ml screen the dosage of the additive is good to control. because of the screw top you can refill without using a funnel.



the dosage unit

The unit of dosage is completely spilled in the compact cabinet incl. the controlling print. It does not exist any precondition because of the construction the transmission you have only to stick. The program connection is above the vacuum side and is kept by a pushing fitting in a dry place. .



electric connection valve protector

the connection of the electronically dosage system is very easy.

Note that the Valve-Protector system in venting mode can take up to 6 A current. The fused voltage tap as well as the ground connection must be suitable for this power.

Please perform the following line link

5-pin plug

1. Red	12 Volt ignition (terminal 15)	supply voltage +
2. Brown	Ground	supply voltage ground -
3. Violet	Measure wire to LPG or Gasoline Injector	signal any LPG Injector
4. Yellow	Signal-output Led	signal output control lamp
5. White	open Collector-Output (switch to ground) for switch off LPG plant	output ground by Stop

2-pin plug:

1. Grey	Input of additive tank fill level sensor	level sensor
2. Brown	Input of additive tank fill level sensor	level sensor

instruction of connection:

The outcome for the system cut off (white) is stressed up to 150mA and can be used for the switching of a relay. The relay contact can be switched in the control pipeline of different valve of the gas installation and makes it unable to use it by empty additive tank.

The output potential of the empty notification (yellow) you can switch by the focus menu. So you can connect a LED signal directly without resistance against ground or also a buzzer (max 50mA) against 12 volt. For the connection of the light emitting diode please connect the the yellow wire of the module with the red wire on the notification Led and connect the blue wire of the notification LED with ground

for attention: Please don't use the LED directly with 12 V because it is ruined directly. The notification (yellow) is made for using a LED and limits the power to 15mA.

Interpreting the control lamp:

OFF - System is ok

Slowly blinking (1-second intervals) – additive level low (approx. 100 ml remaining)

Blinking rapidly (0.2 sec. intervals) – additive empty, system has switched off (no additive dosing)

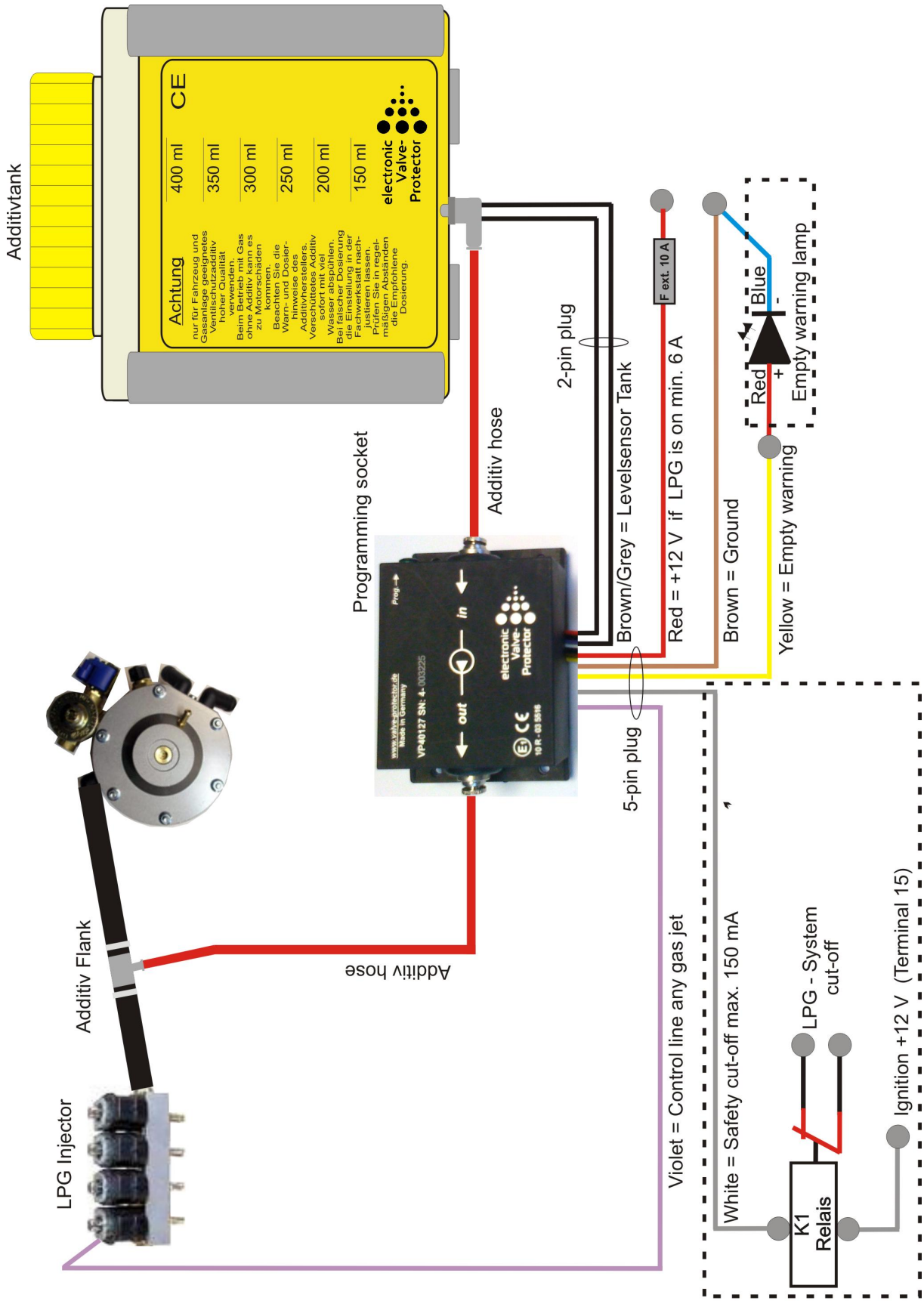

Connection diagram for sensitive relays to switch off the LPG plant

Basic circuit of the electronic sensitive-relays

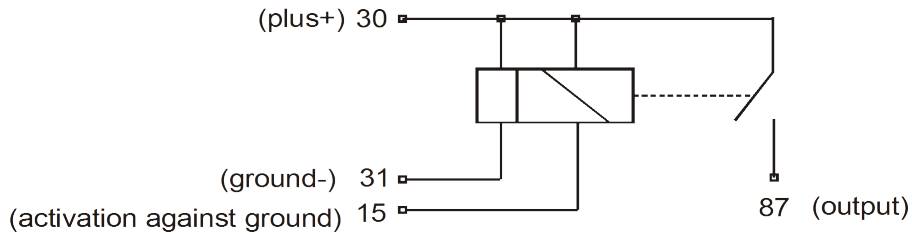

example for switching off the LPG plant by cut of the vaporiser

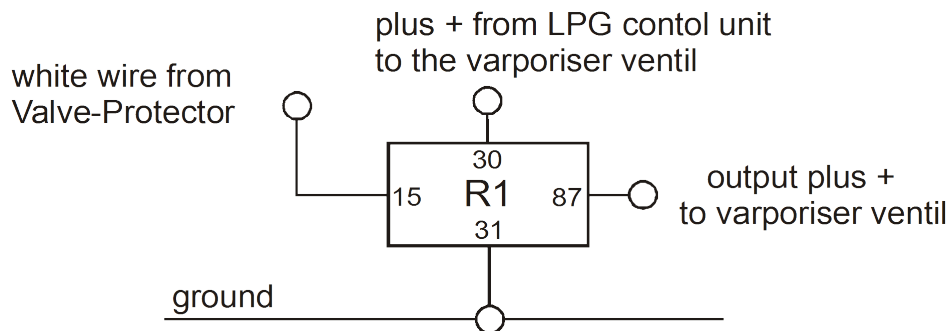

Additional info for settings in the valve-protector software

For the previous example the Software have to be change as follows :
 <Settings> (F7) / activate <Experts> (Set option)/ click Tab sheet <Advanced>” /
 The Field “System shutdown” have to be changed to “Inverted”.
 The “white wire” at the Valve-Protector in the new small Box is able to switch a current up to an maximum of 2A.

installation and starting electronic-Valve-Protector:

1. install the additive tank with the added holder on a possible place.
2. install the dosage module on a possible place
by installation please notice that you can reach the programming socket and the tube set connect.
3. connect the tank and the come in of the dosage module using the pa-tube (carefully do not break the tube and cut it with a possible tube cutter) the straight cut tube has to be put about 12 mm into the plug. to remove the tube the link on the quick catch has to be pressed and now the tube can be pull out..Don`t fit the cut near turning parts.
4. the additive start connection can start as following

a. Additive start in the low pressure side

The starting of the additive during the gas phase is the best way to distribute the additive. The induction into the gas fluid will be act before the gas injectors. Install the additive flank into the gas tube between the evaporator and the gas injectors respectively the mixture sheet . Turn the socket connection for the additive conduction with the integrated non return valve down to work against possible gas bubbles building. To work against that rest of additive run back into the evaporator it is recommended to install the T-fitting with a gradient in the direction of the nozzle. Protect the T-piece with the included clips. Put in the additive tube after the airing (look point 8)

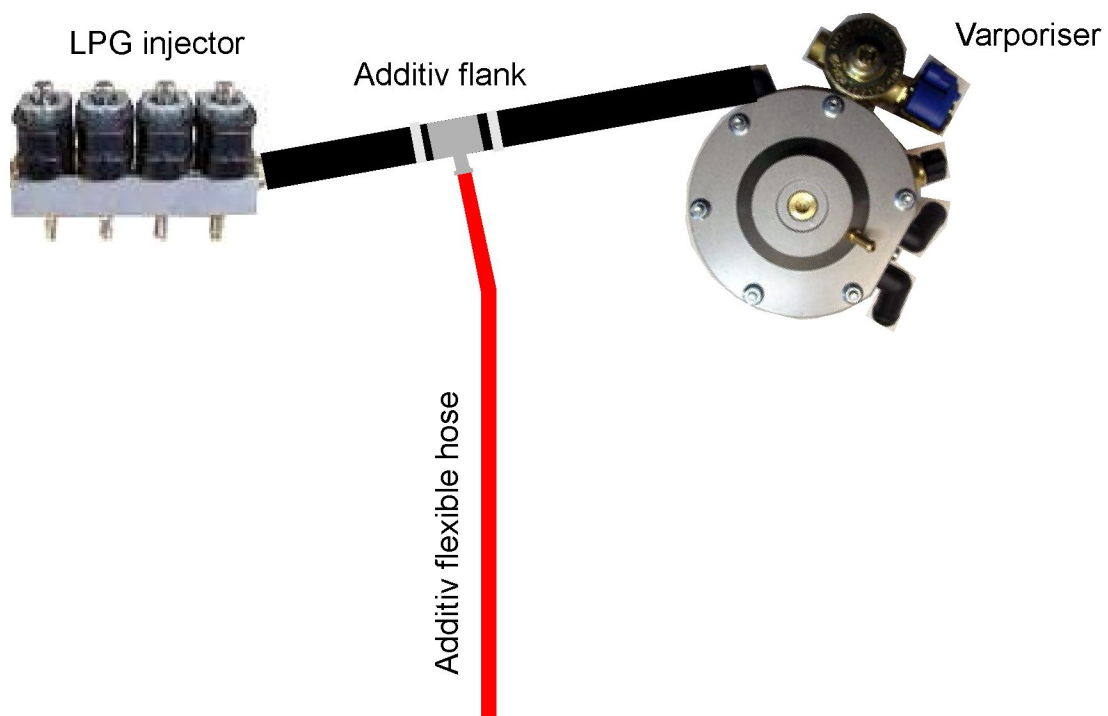

b. Additive induction in front of the throttle

drill a 4,2 mm hole at a central position of the air intake manifold, cut a m5 thread. turn in the additive nozzle with the help of thread leakproof, up to the end of the nozzle looks out 10 mm of the air sucking canal safe the thread socket extra with a counter nut put in the additive tube after the airing (look point 8)

5. please establish all necessary electronically contacts (see connection instructions)

6. now you fill the additive tank with valve-saver fluid. proof the system if it is tight..

7. with the programming cable please connect the programming socket of the dosage module with your USB connection of your laptop or pc system. put on the voltage for the valve protector. Please start the valve protector software the connect line by the valve protector monitor should show you the connection with the dosage module.

8. before using you absolutely have to bleed the system.

because for a perfect using of the system an air free additive pipeline is very important, because when there are air bubbles in the additive pipeline or in the pump the necessary system pressure cannot build up and it can come to faults. Therefore please bleed very carefully and look to the following instructions.

please put the pa tube, which you cut to the right length, before plug into the socket connection on the end of the dosage module. The open end of the pa tube, please put in the right reception tank (empty additive bottle). Now you select the point <settings> in your programming software. Start the ventilation program above your screen and the function starts automatically for 20 sec. please repeat this function so long till there comes additive without air bubbles out of the end of your tube. the period of the airing is depended of the length of the additive pipeline you have used. If the additive pump is dry, the suck in of the additive can take a time longer. If you put the button „stop ventilation“ you can stop the ventilation immediately. The ventilation have to be done only one time after the installation. When the plant is put into operation, the system always looks for the additive fullness and stops before emptiness. Be carefully, additive can damage rubber respectively plastic parts. Overflow additive please wash off with much water. .

9. After the ventilation you can put the pressure hose in the right additive connection.

10. Now press <read device> (F11) to read the parameters from the dosage module. Tune up the right parameter of the engine in the valve protector software. When the cursor stay over an input box you get help on the right field of the program-window for each field. Push the button <write device> (F12) to send all the values to the dosage module.

11. The system now is ready installed and you can start.

12. trial run:

please select the point live in the program software.

start the engine and look at the monitor. when the engine goes by gas the monitor of the injection times should show you the actual injection times of the connecting nozzle.

the pump activity motor should fill about 100%. If 100% are reached an additive dosage will be produced and the pulse monitor will be set down on 00.

in parking gas about all 20-180 sec. an additive dosage will be made according to the engine characteristic. The time up to the next additive production is conditional on the run through the nozzle. Now open the additive tank and press the flow switch of the level sensor aprox. 10 sec. down, using a screwdriver. The level lamp (LED) respectively the summer should begin to blink slowly respectively to beep. When the flow switch gets at the top the advice will be stop after 10 sec.

information

after you drove 1000 kilometre with gas please control the take out of the additive. for the right dosage please look at the instructions of the additive producer.

If the dosage of the additive is to low or to high please intensify or reduce the value of the field <dosage quantity> in the program settings.

Quick start instructions – Amount setting

The Electronic Valve Protector module is equipped with a touch sensor (chrome ring). This metallic chrome ring reacts to touch by finger – just like a button. On the left side wall of the module, an LED is installed, which indicates the various functions with three colours (red-green-yellow) (see the following installation instructions).

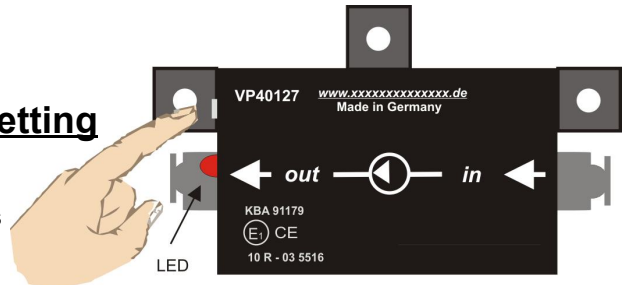

Step 1: Start the vehicle and activate gas operation. The dosing module is now provided with power and remains in Set-up ready mode (LED lights up yellow) for 30 seconds.



Step 2: While the yellow LED is on, touch the metallic chrome ring with your finger until the LED lights up green. Then remove your finger.



Step 3: The LED now flashes x times and indicates the set amount of cylinders. You can set between 1 and 16 cylinders. To change the number of cylinders, simply tap on chrome ring with your finger until you have reached the required number or cylinders. The flash display will always show the number of cylinders set. Once level 16 has been reached, counting starts again at 1. **(Factory setting 4 cylinders)**

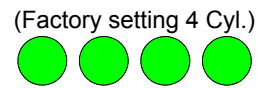

Step 4: Once you have set the required number of cylinders, hold down your finger on the chrome ring until the LED light is red. You are now in the setting menu for dosage level setting.



Step 5: The LED now flashes x times red and displays the set dosage level. There are 15 dosage levels and one level for a quick test run. (Attention: Do not run test run excessively as otherwise too much additive is fed-in). Check the guide level table at the end of this page for the correct dosage level for your vehicle. **(Factory setting level 9)** To change the dosage level simply tap on to the chrome ring with your finger until the required dosage level is reached. The flash display always shows the set dosage level. After level 16, counting starts again at level 1.

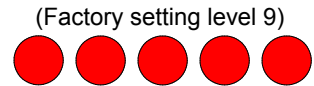

Step 6: Once you have reached the desired dosage level, (see required number of flashes), touch the tube connection until the LED light is yellow. For venting of the module the pump can switch on or off by pressing the chrome ring.



Step 7: Once you have reached the desired dosage level, (see required number of flashes), touch the chrome ring until the LED light is green. The settings are now stored and the module is in operation mode. The module remains in set-up ready mode (LED yellow) following each restart. If during this phase, the chrome ring is not touched, the module automatically changes into working mode (LED green) after 30 seconds. The setting Table is only a guide! The correct dosage must be checked after each installation and adjusted if required.



Display of LED built-in module

LED light is green: System has operating voltage but is not receiving control impulses from the gas injector.

LED flashes green: System has operating voltage and is receiving control impulses from the gas injector (operating mode)

LED slowly flashes red (every second): no input from level sensor into additive tank

LED quickly flashes red (every 0.25 sec.): additive depleted

LED flashes yellow (every 0.5 sec.): additive is being injected

Display of LED to be installed in passenger area

LED flashes 3 times for operation control. power on control

LED flashes slowly (every second): remaining additive level reserve approx. 100 ml

LED flashes quickly (every 0.25 sec.): additive depleted.

Guide level table for base amount setting per Cylinder

Level	1	2	3	4	5	6	7	8	9	10	11	12	13	14	15	16
Cylinder capacity KW	4	5	7	8	10	13	16	20	26	32	40	56	64	80	112	Test
Cylinder capacity PS	5	7	10	11	14	18	22	27	35	43	54	76	87	108	152	Test

Safety directions

functional using

valve protector is an electric regulated dosage unit and consist of the following components: additive tank, electric regulated dosage module, introduction connection
The functional using is to add qualified and decontrolled additive for combustion engine.

Valve protector is developed and built based by the validate safety guidelines, only for using in European community.

It may only be used under the following conditions:

1. In technically faultless condition
2. After careful leak testing
3. Having been installed and brought into operation by a skilled professional
4. Used only for the intended purpose
5. Failure to observe the safety notices can lead to personal injury and material damage
6. Electrical lines and additive lines must always be laid in such a way as to rule out damage and chafing
7. Observe the additive manufacturer's safety guidelines
8. Compatibility between the additive and the components through which it flows has been checked and confirmed
9. Check for correct dosage at regular intervals
10. In the case of over/underdosage, have the system checked in an authorized service centre.
11. Driving with incorrect dosages can cause damage to your engine and/or exhaust system.
12. Rinse off any spilt additive with plenty of water
13. Refill the additive tank level when it gets low
14. Do not fill above the fill line
15. Never mix different additives
16. Use only approved and authorized additives
17. Using unauthorized additives can forfeit your operating licence
18. Use only original replacement parts
19. The specified durabilities and applications are only "reference values" and do not absolve the customer of his responsibility to perform his own tests or evaluation of the suitability for the application. Please note that elastomers have a limited service life, e.g. due to aging. We therefore recommend regular inspection and change intervals. All information provided is correct to the best of our knowledge. We make no guarantee, however, as to the correctness and completeness of this information.
20. The warranty period is 24 months. The warranty becomes void in the case of improper use of the device, use outside the technical specifications, use of an unapproved additive, improper operation or unauthorized interference. We are not liable for any damage resulting from these cases. The exemption from liability also extends to all services performed by third parties that have not been ordered in writing by us.